



Driver LC 21W 700mA UNV C ADV

Compact advanced series (Universal voltage)

Product description

- Built-in constant current LED Driver
- For dry and damp location
- For luminaires of protection class I and protection class II
- Temperature protection as per EN 61347-2-13 C5e
- UL and ENEC certified
- Max. output power 21 W
- Up to 86 % efficiency
- Nominal life-time up to 50,000 h
- 5-year guarantee

Housing properties

- Casing: plastic, white
- Potted version
- Type of protection IP44

Interfaces

- Single wires with tinned wire ends

Functions

- Overtemperature protection
- Overload protection
- Short-circuit protection
- No-load protection
- Burst protection voltage 1 kV
- Surge protection voltage 1 kV (L to N)

Typical applications

- For linear/area lighting in office applications



Standards, page 3

Wiring diagrams and installation examples, page 3

IP44 SELV       

Driver LC 21W 700mA UNV C ADV

Compact advanced series (Universal voltage)

Technical data

Rated supply voltage	120 – 277 V
AC voltage range	108 – 305 V
Max. input current (at 277 V, 60 Hz, full load)	0.1 A
Max. input current (at 120 V, 60 Hz, full load)	0.23 A
Mains frequency	50 / 60 Hz
Overvoltage protection	320 V AC, 2 h
Max. input power	25 W
Typ. power consumption (at 230 V, 50 Hz, full load)	23 W
Min. output power	10 W
Max. output power	20 W
Typ. efficiency (at 230 V / 50 Hz / full load) ^①	86 %
λ (at 230 V, 50 Hz, full load) ^①	0.95
Output current ^②	700 mA
Output current tolerance ^②	± 5 %
Max. output current peak (non-repetitive)	770 mA
Typ. current ripple (at 230 V, 50 Hz, full load)	± 30 %
Min. forward voltage	14 V
Max. forward voltage	28 V
Max. output voltage	33 V
THD (at 230 V, 50 Hz, full load)	< 20 %
Starting time (at 230 V, 50 Hz, full load)	≤ 0.5 s
Turn off time (at 230 V, 50 Hz, full load)	≤ 0.1 s
Hold on time at power failure (output)	0 s
Max. casing temperature t_c	85 °C
Ambient temperature t_a	-20 ... +60 °C
Ambient temperature t_a (at life-time 50,000 h)	50 °C
Storage temperature t_s	-40 ... +80 °C
Life-time	up to 50,000 h
Dimensions L x W x H	95 x 40 x 25.4 mm

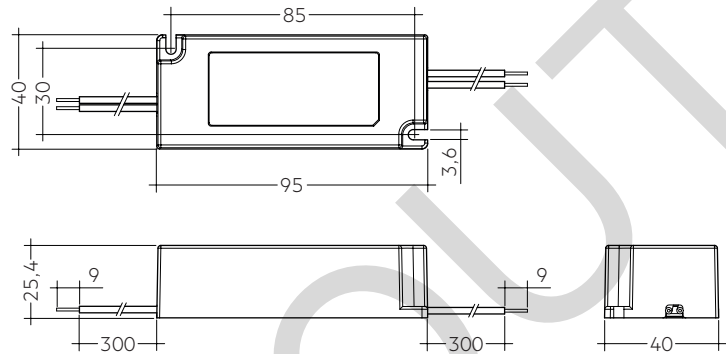

Ordering data

Type	Article number	Packaging, carton	Packaging, pallet	Weight per pc.
LC 21W 700mA UNV C ADV	28001760	40 pc(s).	1,920 pc(s).	0.16 kg

^① Test result at 700 mA.

^② Output current is mean value.

1. Standards

EN 55015
 EN 61000-3-2
 EN 61000-3-3
 IEC 61000-4-2
 IEC 61000-4-3
 IEC 61000-4-4
 IEC 61000-4-5
 IEC 61000-4-6
 IEC 61000-4-8
 IEC 61000-4-11

EN 61347-1
 EN 61347-2-13
 EN 61547
 UL8750 with Class 2 output based on UL1310
 FCC Part 15 Class B

1.1 Glow wire test

according to EN 60598-1 with increased temperature of 850 °C passed.

2. Thermal details and life-time

2.1 Expected life-time

Expected life-time

Type	ta	40 °C	45 °C	50 °C	55 °C	60 °C
LC 21W 700mA UNV C ADV	tc	60 °C	65 °C	70 °C	75 °C	80 °C
	Life-time	>100,000 h	90,000 h	60,000 h	40,000 h	30,000 h

The LED Driver is designed for a life-time stated above under reference conditions and with a failure probability of less than 10 %.

The relation of tc to ta temperature depends also on the luminaire design. If the measured tc temperature is approx. 5 K below tc max., ta temperature should be checked and eventually critical components (e.g. ELCAP) measured. Detailed information on request.

3. Installation / Wiring

3.1 Wiring diagram

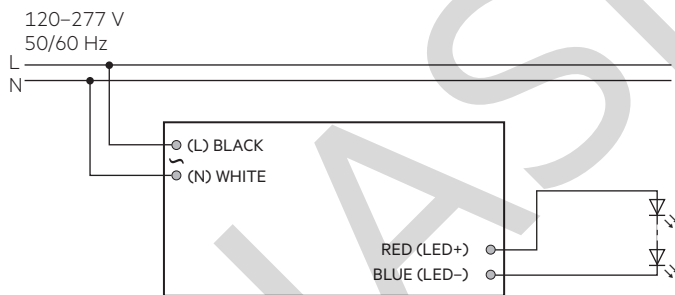

Primary wire		Secondary wire	
L	N	LED+	LED-
black	white	red	blue



3.2 Wiring guidelines

- All connections must be kept as short as possible to ensure good EMI behaviour.
- Mains leads should be kept apart from LED Driver and other leads (ideally 5 – 10 cm distance)
- Max. length of output wires is 2 m.
- Incorrect wiring can damage LED modules.
- To avoid the damage of the Driver, the wiring must be protected against short circuits to earth (sharp edged metal parts, metal cable clips, louver, etc.).

3.3 Hot plug-in

Hot plug-in or secondary switching of LEDs is not permitted and may cause a very high LED output current.

3.5 Replace LED module

1. Mains off
2. Remove LED module
3. Wait for 5 seconds
4. Connect LED module again

3.6 Installation instructions

The LED module and all contact points within the wiring must be sufficiently insulated against 2 kV surge voltage. Air and creepage distance must be maintained.

4. Electrical values

4.1 Efficiency vs. load

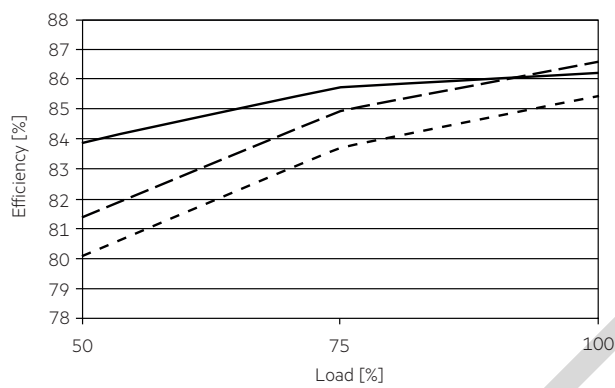

4.2 Power factor vs. load

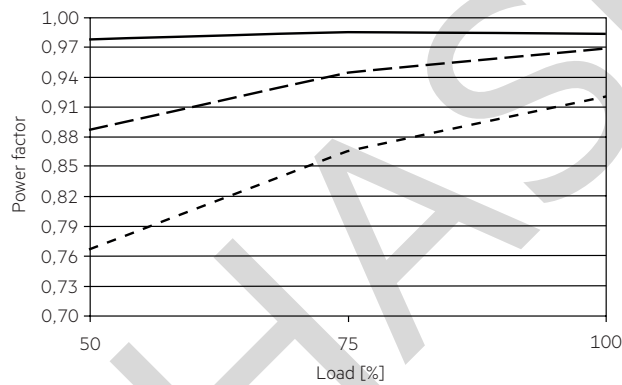

4.3 THD vs. load

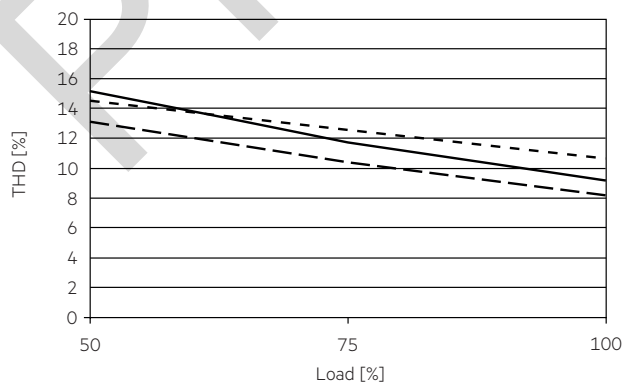

4.4 Input current vs. load

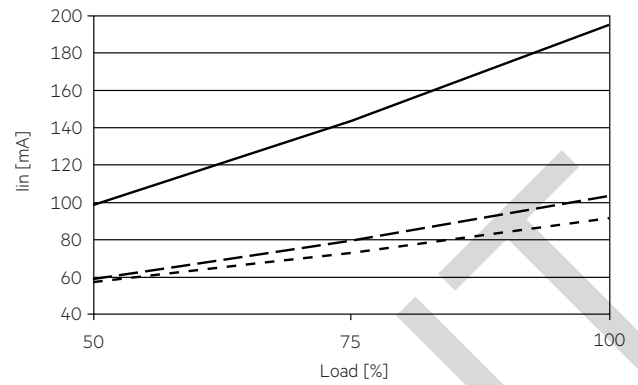

4.5 Input power vs. load

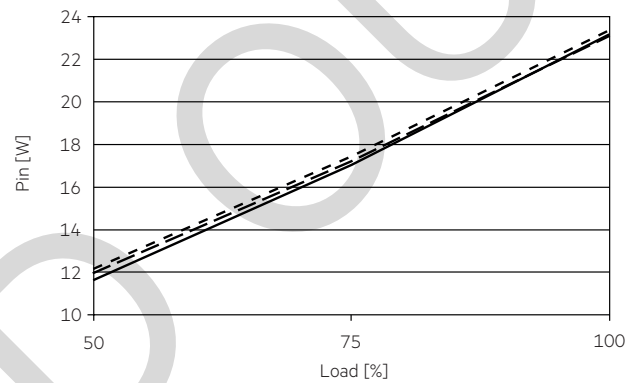

— 120 V
 - - - 230 V
 - · - 277 V

4.6 Maximum loading of automatic circuit breakers in relation to inrush current

120 V, 60 Hz

Automatic circuit breaker type	C10	C13	C16	C20	B10	B13	B16	B20	Inrush current	
Installation Ø	1.5 mm ²	1.5 mm ²	1.5 mm ²	2.5 mm ²	1.5 mm ²	1.5 mm ²	1.5 mm ²	2.5 mm ²	I _{max}	Time
LC 21W 700mA UNV C ADV	35	46	56	70	35	46	56	70	47 A	2 µs

230 V, 50 Hz

Automatic circuit breaker type	C10	C13	C16	C20	B10	B13	B16	B20	Inrush current	
Installation Ø	1.5 mm ²	1.5 mm ²	1.5 mm ²	2.5 mm ²	1.5 mm ²	1.5 mm ²	1.5 mm ²	2.5 mm ²	I _{max}	Time
LC 21W 700mA UNV C ADV	47	61	75	94	32	41	51	64	94 A	2 µs

230 V, 50 Hz

Automatic circuit breaker type	C10	C13	C16	C20	B10	B13	B16	B20	Inrush current	
Installation Ø	1.5 mm ²	1.5 mm ²	1.5 mm ²	2.5 mm ²	1.5 mm ²	1.5 mm ²	1.5 mm ²	2.5 mm ²	I _{max}	Time
LC 21W 700mA UNV C ADV	43	56	69	86	26	34	41	52	116 A	14 µs

This are max. values calculated out of inrush current! Please consider not to exceed the maximum rated continuous current of the circuit breaker. Calculation uses typical values from ABB series S200 as a reference. Actual values may differ due to used circuit breaker types and installation environment.

4.7 Harmonic distortion in mains supply (at 230V / 50 Hz and full load) in %

	THD	3.	5.	7.	9.	11.
LC 21W 700mA UNV C ADV	< 20	< 3	< 1	< 1	< 1	< 1

5. Functions

5.1 Short-circuit behaviour

In case of a short circuit at the output of the LED driver, the output operates in hiccup mode.

5.2 No-load operation

The LED Driver will not be damaged in the no-load operation. A voltage of 33 V DC is permanent at the output.

5.3 Overload protection

In case of exceeding the maximum allowed LED voltage at the output, the LED driver will reduce the output current.

5.4 Overtemperature protection

The LED Driver is protected against temporary thermal overheating. If the temperature limit is exceeded, the output of the LED driver operates in hiccup mode. The temperature protection is activated approx. +10 °C above T_c max.

6. Miscellaneous

6.1 Insulation and electric strength testing of luminaires

Electronic devices can be damaged by high voltage. This has to be considered during the routine testing of the luminaires in production.

According to IEC 60598-1 Annex Q (informative only!) or ENEC 303-Annex A, each luminaire should be submitted to an insulation test with 500 V_{DC} for

1 second. This test voltage should be connected between the interconnected phase and neutral terminals and the earth terminal. The insulation resistance must be at least 2 MΩ.

As an alternative, IEC 60598-1 Annex Q describes a test of the electrical strength with 1500 V_{AC} (or 1.414 x 1500 V_{DC}). To avoid damage to the electronic devices this test must not be conducted.

6.2 Conditions of use and storage

Humidity: 5 % up to max. 85 %, not condensed (max. 56 days/year at 85 %)

Storage temperature: -40 °C up to max. +80 °C

The devices have to be within the specified temperature range (t_a) before they can be operated.

6.3 Maximum number of switching cycles

All LED Driver are tested with 50,000 switching cycles. The actually achieved number of switching cycles is significantly higher.

6.4 Additional information

Additional technical information at www.tridonic.com → Technical Data

Guarantee conditions at www.tridonic.com → Services

Life-time declarations are informative and represent no warranty claim. No warranty if device was opened.