



DALI Interface RS232 PS/S

PC interface module for DALI systems

Product description

- Combines interface module and DALI power supply
- Integrated power supply with 240 mA for DALI devices or DALI control modules without power supply
- Interface module for connection of DALI systems with computer or programmable control systems
- For installation in switching cabinets
- 5-year guarantee

Technical data

Rated supply voltage	110 – 240 V
Permitted input voltage	110 – 260 V
Mains frequency	50 / 60 Hz
Power	1 – 6 W
Standby power	1 W
Max. output current, DALI	240 mA
Output voltage	16 V ±5 %
Operating temperature	0 ... +50 °C
Storage temperature	-20 ... +60 °C
Max. casing temperature tc	80 °C
Permitted relative humidity	10 – 90 %, not condensed
Mounting	DIN rail mounting, 35 mm
Casing material	PC, flame retardant, halogen-free
Type of protection	IP20

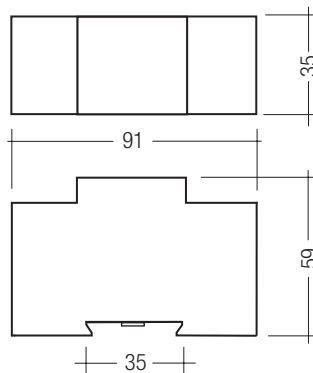

Ordering data

Type	Article number	Packaging, carton	Weight per pc.
DALI Interface RS232 PS/S	28001847	100 pc(s).	0.09 kg



Standards, page 3

Wiring diagrams and installation examples, page 3

Specific technical data

Type	Input RS232	DALI output
DALI Interface RS232 PS/S	1	1

DALI Interface RS232 cable

Product description

- Connection cable 1 m for connection of computer with DALI Interface RS232 PS/S
- RJ45 to D-sub unshielded

**Ordering data**

Type	Article number	Length	Packaging	Weight per pcs.
DALI Interface RS232 cable	28000087	1 m	1 pc(s).	0.06 kg

1. Standards

- EN 55022
- EN 60950-1
- EN 61000-3-2
- EN 61000-3-3
- EN 61000-6-2
- EN 61547

1.1 DALI standard

DALI Interface RS232 PS/S is designed to control control gear with DALI standard IEC 60929 (DALI V0) and IEC 62386 (DALI V1).

1.2 Glow-wire test

according to EN 60598-1 with increased temperature of 850 °C passed.

2. Installation

- DALI signals are not SELV. Therefore the same procedures should be applied as working with mains voltage
- Individual DALI circuits must not exceed 240 mA
- The maximum cable length of the DALI signal wires must not exceed 300 m or drop more than 2 V on the signal line voltage
- The function of the DALI RS232 Interface is tested with all Tridonic DALI products and the functional guarantee applies only with these products

2.1 Connection diagram

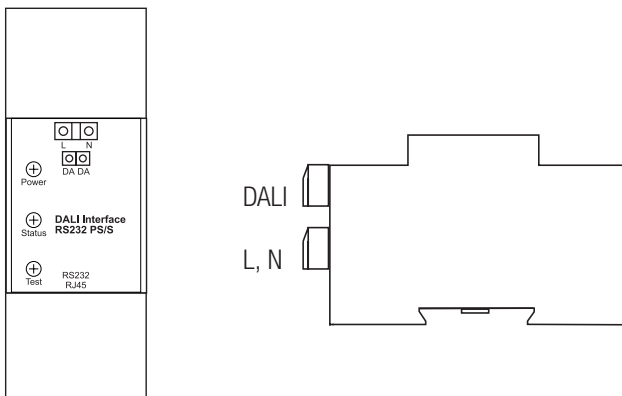

2.2 Wiring

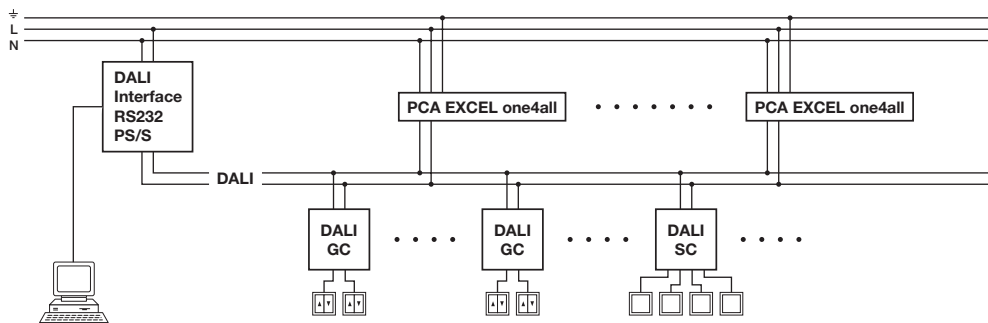

2.3 Wiring type and cross section

The wiring can be solid wire, stranded wire or stranded wire with end sleeve with a cross-section of 0.75 mm² to 2.5 mm².

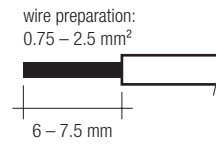

2.4 tc control point

tc: max. 80 °C

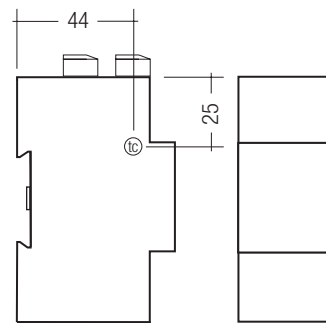

3. Functions

3.1 Power-LED

green fault-free operation
 off device or power failure

3.2 Status-LED

green, intermittently flickering	fault-free operation
green, flashing on/off every 0.5 s	test mode: manually repeated
orange, flashing on/off every 0.5 s	test mode: automatically repeated
off	device or power failure
red, intermittently flickering	deficiency at DALI/DSI output

3.3 Test / configuration key

The test key can be used to trigger tests as well as certain functions.
 Triggering a function:

- Press test key.
- Release the test key in the desired orange phase. Function is triggered.

3.4 Orange phase

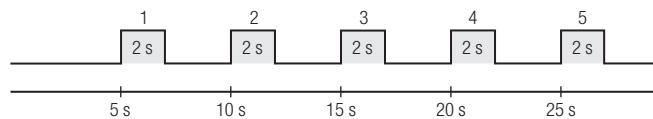

Orange phase	Function
1	Terminate test mode
2	Test mode: automatically repeated
3	Display configuration of the RS232 (RJ45) interface
4	Switch to data transfer mode 1 (DALI SCI)
5	Switch to data transfer mode 2 (DALI SCI2)

3.5 Test mode

Manually repeated:

- Hold test key down for maximum 2 seconds. The status LED will start to flash green and all luminaires will be switched on.
- Each further press of the key of less than 2 seconds switches the luminaires on and off in turn.
- To terminate the test mode, press the test key and release during the 1st orange phase. Test mode is automatically terminated if a DALI command is received.

Automatically repeated:

- Press test key.
- Release test key during the 2nd orange phase. All luminaires are switched on and off every 2.5 seconds.
- To terminate the test mode, press the test key and release during the 1st orange phase.

3.6 Configuration of the RS232 (RJ45) interface

The RS232 (RJ45) interface of the DALI Interface RS232 PS/S allows two types of data transfer:

Data transfer mode 1	Data transfer mode 2 (default)
Transfer rate: 19,200 baud	Transfer rate: 38,400 baud
Unidirectional transfer of DALI/DSI commands	Bidirectional transfer of DALI/DSI commands
Replaced DALI SCI (24033463)	Replaced DALI SCI2 (24166096)

3.7 Display configuration of the RS232 (RJ45) interface

- Press test key.
- Release test key during the 3rd orange phase.

Current configuration is displayed:

Data transfer mode	Status LED
Data transfer mode 1 (DALI SCI)	Orange, once 0.5 sec on/off
Data transfer mode 2 (DALI SCI2)	Orange, twice 0.5 sec on/off

3.8 Switch to data transfer mode 1 (DALI SCI)

- Press test key.
- Release test key during the 4th orange phase. DALI Interface RS232 PS/S switches to data transfer mode 1.

3.9 Switch to data transfer mode 2 (DALI SCI2)

- Press test key.
- Release test key during the 5th orange phase. DALI Interface RS232 PS/S switches to data transfer mode 2.

3.10 Safety instructions



The device may only be used for the application area specified.

Relevant health and safety regulations must be observed.

The voltage supply must be disconnected when the device is being assembled and installed.

Only qualified personnel may assemble, install and commission the device.

Don't use the DALI Interface RS232 PS/S with other voltage delivering devices (e.g. DALI PS).

An other method to test if a further voltage delivering device is in the DALI signal wire:

DALI Interface RS232 PS/S connect without mains supply to the DALI signal wire.

If the power LED and the status LED are on despite without mains supply of the DALI Interface RS232 PS/S (typically green) then it is a forbidden supply of the DALI signal wire through an other device.

3.11 Connection:

The RS232 Signals RTS and DTR must be set to the following levels before any communication can take place:

RTS = +6 ... +12 V

DTR = -6 ... -12 V

This could be done in software or by hardware wiring.

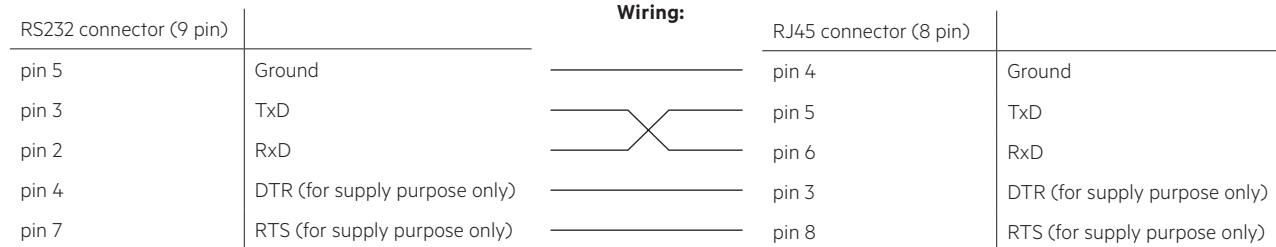

3.12 Maximum length of cable

For Data transfer mode 1 (19,200 Baud) 15 m

For Data transfer mode 2 (38,400 Baud) 5 m

4. Interface description for data transfer mode 1 (DALI SCI):

4.1 Serial Interface Configuration:

19200 baud; 8 data bit; no parity; 1 stop bit (19200, 8, n, 1) half duplex

4.2 Transmission Frame:

The transmission frame consists of 7 bytes:

8 bit	8 bit	8 bit	8 bit	8 bit	8 bit	8 bit
Start/Ctrl	ADDR_HI	ADDR_MID	ADDR_LO	DATA_HI	DATA_LO	Check

4.3 Start/Control:

bit 7	bit 6	bit 5	bit 4	bit 3	bit 2	bit 1	bit 0
0	Identify/nDALI	Echo	DSI/nDALI	0	0	0	0

bit 7: not used, should be set LOW for compatibility with future releases

bit 6: High: no data is sent via the DALI bus. Response only on PC (to check connection)

when DATA_HI = 00h and DATA_LO = 01h, then enable / when DATA_HI = 00h and DATA_LO = 00h, then disable (default: enable)

Low: DALI (DSI) output DALI bus

bit 5: High: immediate reply to PC (not waiting for DALI answer)

Low: waiting for DALI answer (10 ms max.) DALI „NO“ after 10 ms

bit 4: High: Data output using DSI format

DATA_HI = 0: DATA_LO = 8 bit DSI data

DATA_HI > 0: DATA_HI and DATA_LO = 16 bit ext. DSI data

Low: Data output using DALI format

DATA_HI: DALI HighByte

DATA_LO: DALI LowByte

bit 3: not used, should be set LOW for compatibility with future releases

bit 2: not used, should be set LOW for compatibility with future releases

bit 1: not used, should be set LOW for compatibility with future releases

bit 0: not used, should be set LOW for compatibility with future releases

4.4 ADDR_HI ... ADDR_LO

The address (ADDR_HI ... ADDR_LO) is not used by the DALI RS232 Interface, supported for software compatibility with other DALI products only. Should be set to zero.

4.5 Check

XOR-combination of the previous 6 bytes (Start/Control ... to ... DATA_LO).

4.6 DATA_HI, DATA_LO

DALI/DSI data. See Start/Control for a description.

4.7 DALI RS232 Interface answer to PC:

The answer of the DALI RS232 Interface to the PC uses 3 bytes:

8 bit	8 bit	8 bit
Start/Ctrl	DATA	Check

4.8 Start/Control:

bit 7	bit 6	bit 5	bit 4	bit 3	bit 2	bit 1	bit 0
Identifier				Release		Status	

Identifier	DALI SCI ID = 5		
Release	0	(firmware releases Feb. 2001)	Start/Control in current release
Status	00	OK	0x50
	01	DALI Data	0x51
	10	DALI answer "NO"	0x52
	11	Error	check sum: DATA = 1 0x53
		DALI bus short circuit:	DATA = 2
		DALI recive error:	DATA = 3

4.9 Data

If Identify = 1 or Echo = 1: 0 = DALI disable: 1 = DALI enable
 else: DALI answer byte

4.10 Check Sum

XOR-combination of the previous 2 bytes (Start/Control XOR DATA).

4.11 Attention:

The DALI RS232 Interface reply should be checked under all circumstances. This assures the DALI command has been sent (and received) and the DALI RS232 Interface is ready to handle a new command. There is no command buffer in the data transfer mode 1 (DALI SCI)!

5. Interface description for data transfer mode 2 (DALI SCI2):

5.1 Serial Interface Configuration:

38400 baud; 8 data bit; no parity; 1 stop bit (38400, 8, n, 1)
half duplex

5.2 Transmission Protocol:

To communicate with the DALI RS232 Interface the following simple transmission protocol is used.
The forward and backward frame both always consist of 5 bytes.
Send this frame to the DALI RS232 Interface:

8 bit	8 bit	8 bit	8 bit	8 bit
Control	DATA HIGH	DATA MID	DATA LOW	Check Sum

5.3 Control:

bit 7	bit 6	bit 5	bit 4	bit 3	bit 2	bit 1	bit 0
ME	Identify/ nDALI	Echo	DSI/nDALI	0	Mode 2	Mode 1	Mode 0

bit 7: Monitor Enable. 1 = enable monitor function. If enabled the DALI RS232 Interface sends all received DALI data back to the PC.

bit 6: High: no data is sent via the DALI bus. Response only on PC (to check connection)
when DATA_HI = 00h and DATA_LO = 01h, then enable / when DATA_HI = 00h and DATA_LO = 00h, then disable (default: enable)
Low: DALI (DSI) output on the DALI bus

bit 5: High: immediate reply to PC (not waiting for DALI answer)

Low: waiting for DALI answer (10 ms max.) DALI „NO“ after 10 ms

bit 4: High: data output in DSI format

DATA_MID = 0: DATA_LO = 8 bit DSI data

Low: data output in DALI format:

DATA_MID: DALI HighByte (DALI address byte)

DATA_LO: DALI LowByte (DALI command byte)

data output in eD format:

DATA_HI: eD HighByte

DATA_MID: eD MiddleByte

DATA_LO: eD LowByte

bit 3: not used, should be set LOW for compatibility with future releases

bit 2..0: Mode Selection:

0, 1: not used

2: send DALI answer (8 bit data) (DATA_LO)

3: send DALI (16 Bit) (DATA_MID, DATA_LO)

4: send eD (25 bit data) (DATA_HI, DATA_MID, DATA_LO)

5: send DSI (8 bit data if DATA_MID = 0, else 16 bit data (DATA_MID, DATA_LO))

5.4 DATA HIGH, DATA LOW

If sent to the DALI RS232 Interface: DALI/DSI data. See description of the Control byte If received from the DALI RS232 Interface: see below.

The DALI RS232 Interface answer uses 5 bytes to the PC:

8 bit	8 bit	8 bit	8 bit	8 bit
Status	DATA HIGH	DATA MID	DATA LOW	Check Sum

5.5 Status:

bit 7	bit 6	bit 5	bit 4	bit 3	bit 2	bit 1	bit 0
Identifier				Release	Status		

Identifier	DALI SCI2 ID = 6					
Release	0	(firmware release March 2002)				Status byte in current release
Status	000	OK				0x60
	001	DALI answer "NO"				0x61
	010	DALI 8 bit data		DATA = 8 bit DALI	0x62	
	011	DALI 16 bit data		DATA = 16 bit DALI	0x63	
	100	DALI 24 bit data		DATA = 24 bit DATA	0x64	
	101	DSI Data (8 bit if DATA_MID = 0, else 16 bit ext. DSI)				0x65
	110	not used				0x66
	111	Error	Invalid backward frame:	DATA = 0x00	0x67	
			Check sum:	DATA = 0x01		
			DALI-bus short circuit (coming):	DATA = 0x02		
			DALI recive error:	DATA = 0x03		
			DALI-bus short circuit (going):	DATA = 0x0C		

5.6 Check sum

XOR-combination of the previous 4 bytes (Control/Status ... to ... DATA_LO).

5.7 Attention:

The DALI RS232 Interface's reply should be checked under all circumstances. This assures the DALI command has been sent (and received) and the DALI RS232 Interface is ready to handle a new command. There is no command buffer in the data transfer mode 2 (SCI2)!

6. Miscellaneous

6.1 Additional information

Additional technical information at www.tridonic.com → Technical Data

Guarantee conditions at www.tridonic.com → Services

Life-time declarations are informative and represent no warranty claim.
No warranty if device was opened.